

# Therapeutic setting of the hammock Moki (MOK16-33)

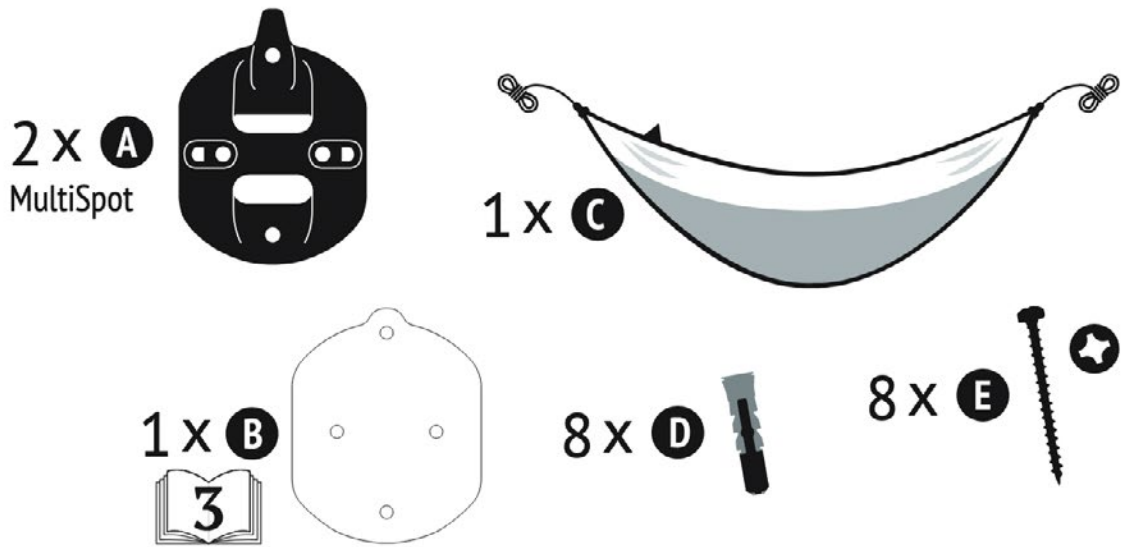

1

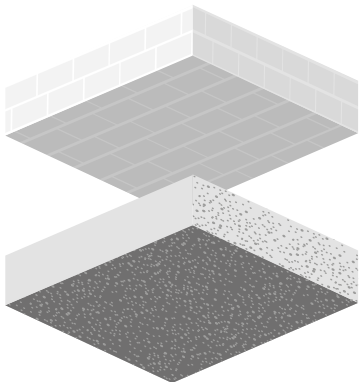

Min. 8,5 cm  
Min. 3.3 Inches

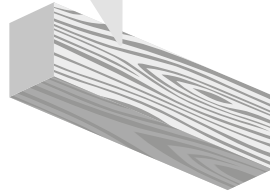

Min. 4 cm  
Min. 1.6 Inches

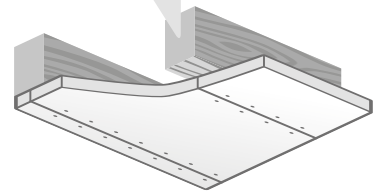

2

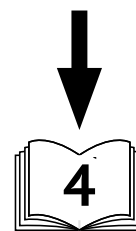
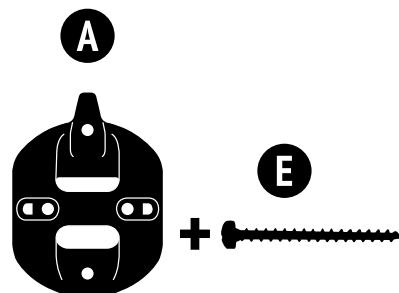
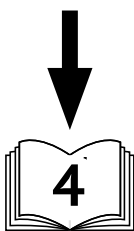
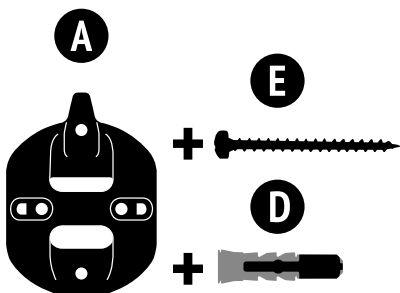
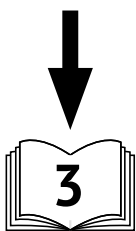

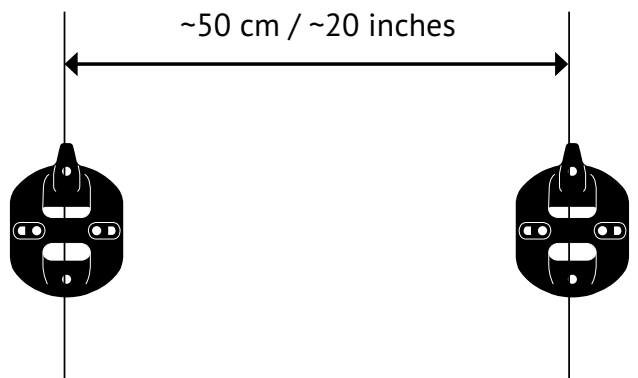
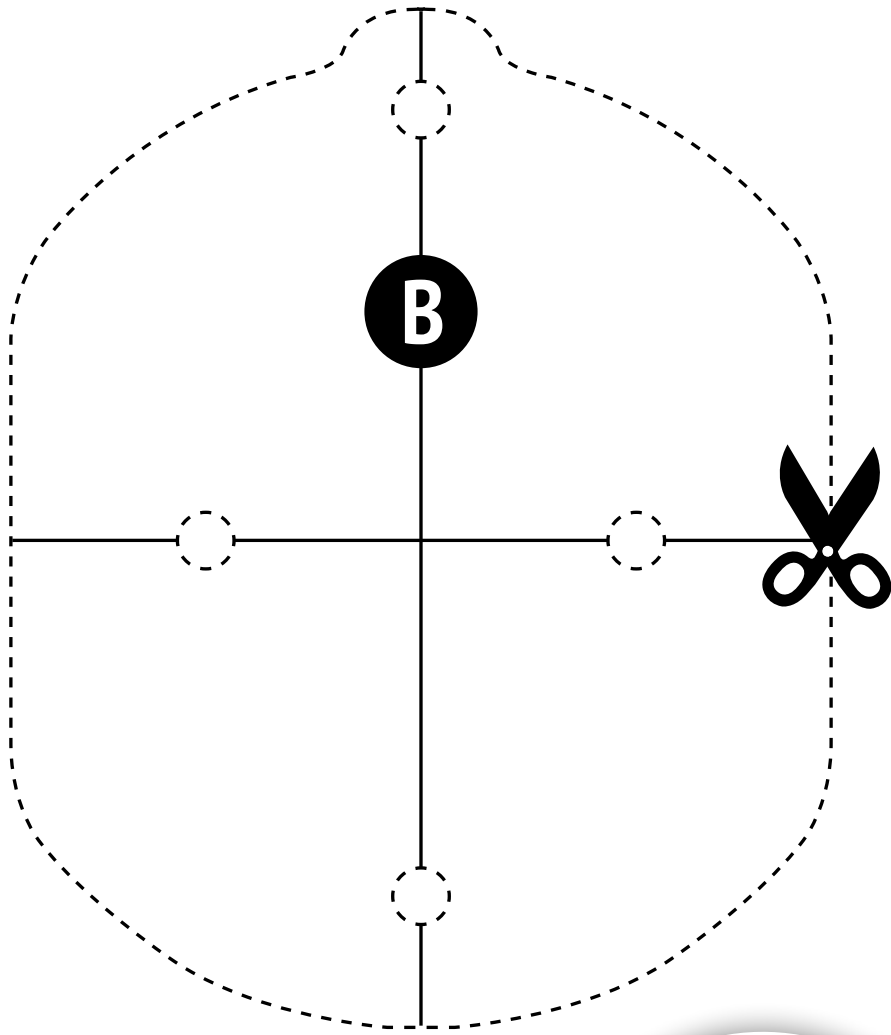

# 2a

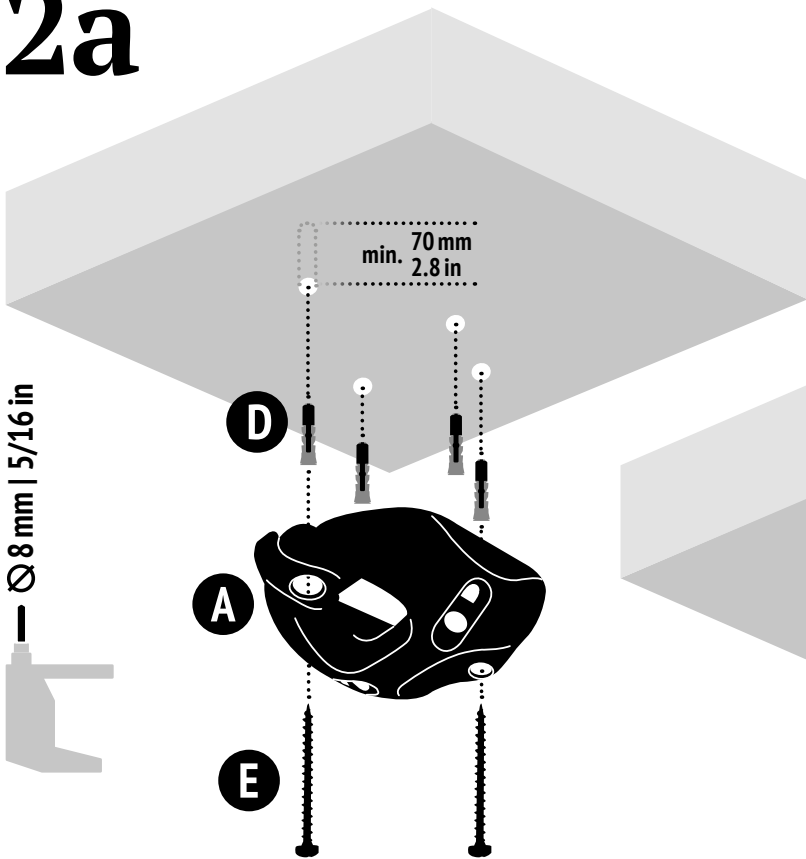

Ø 8 mm | 5/16 in

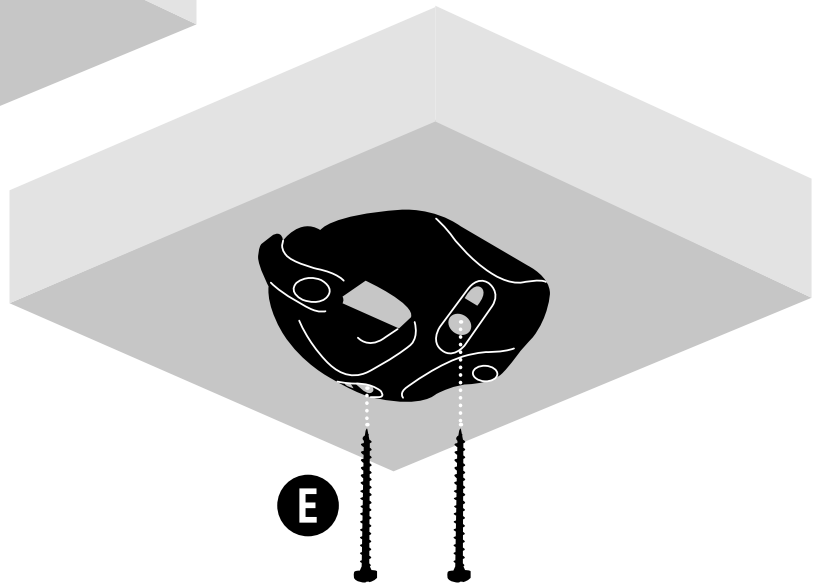

2b

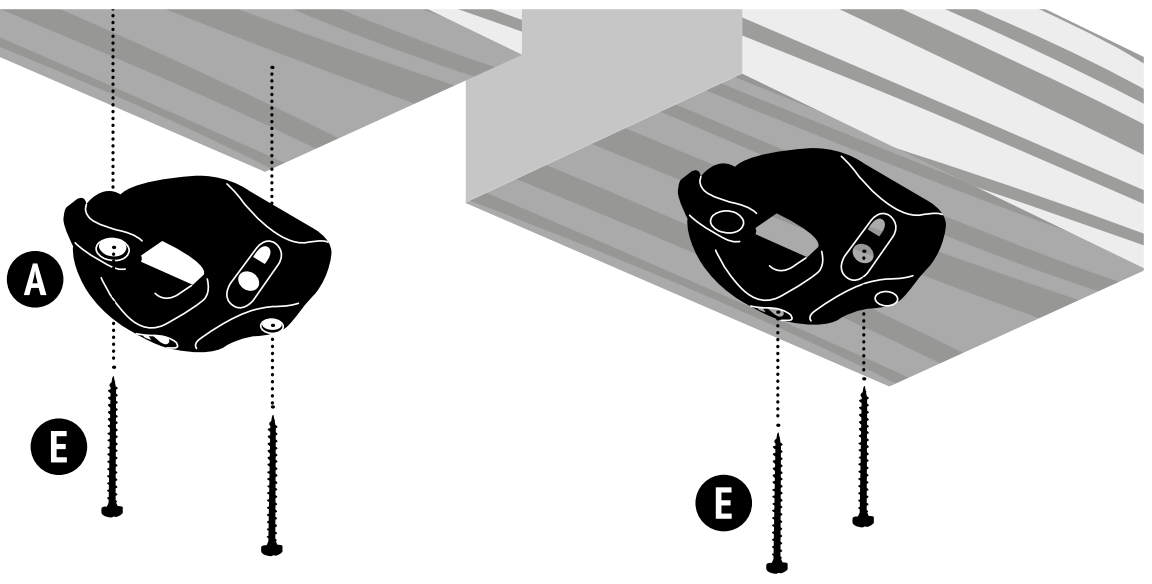

2c

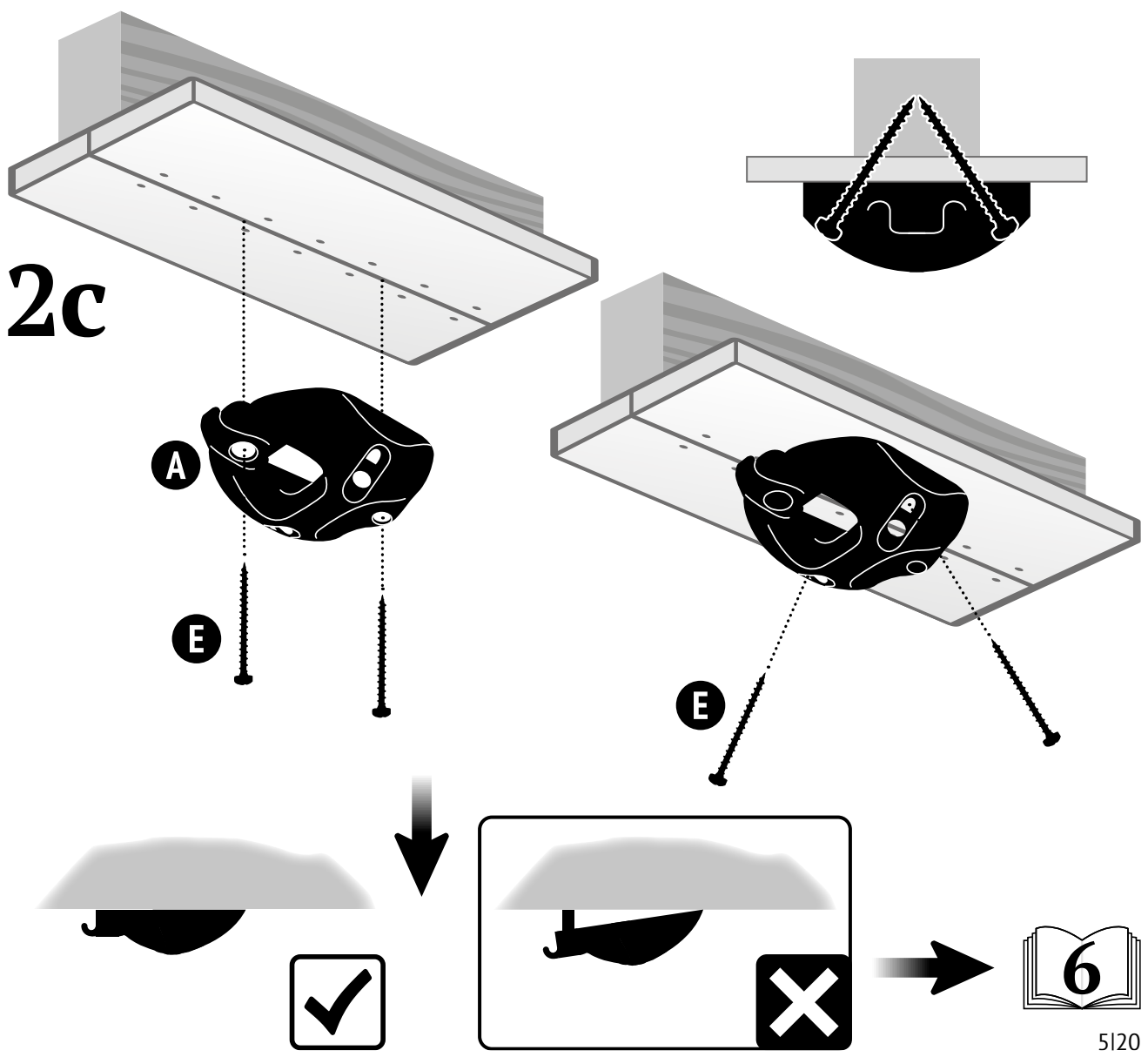

5120

3

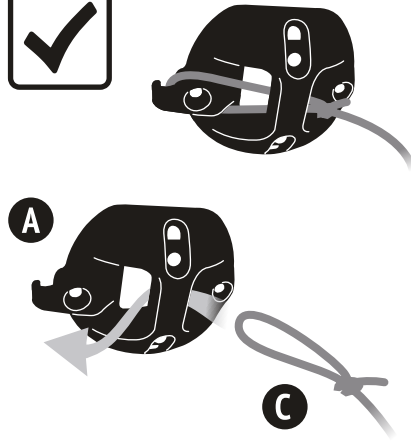
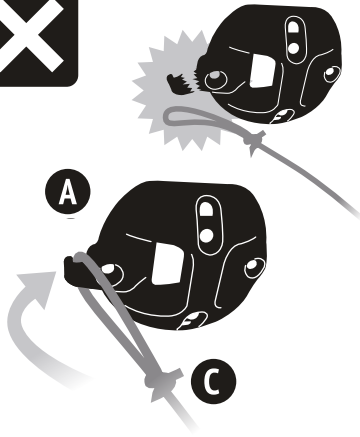



Height  
adjustment

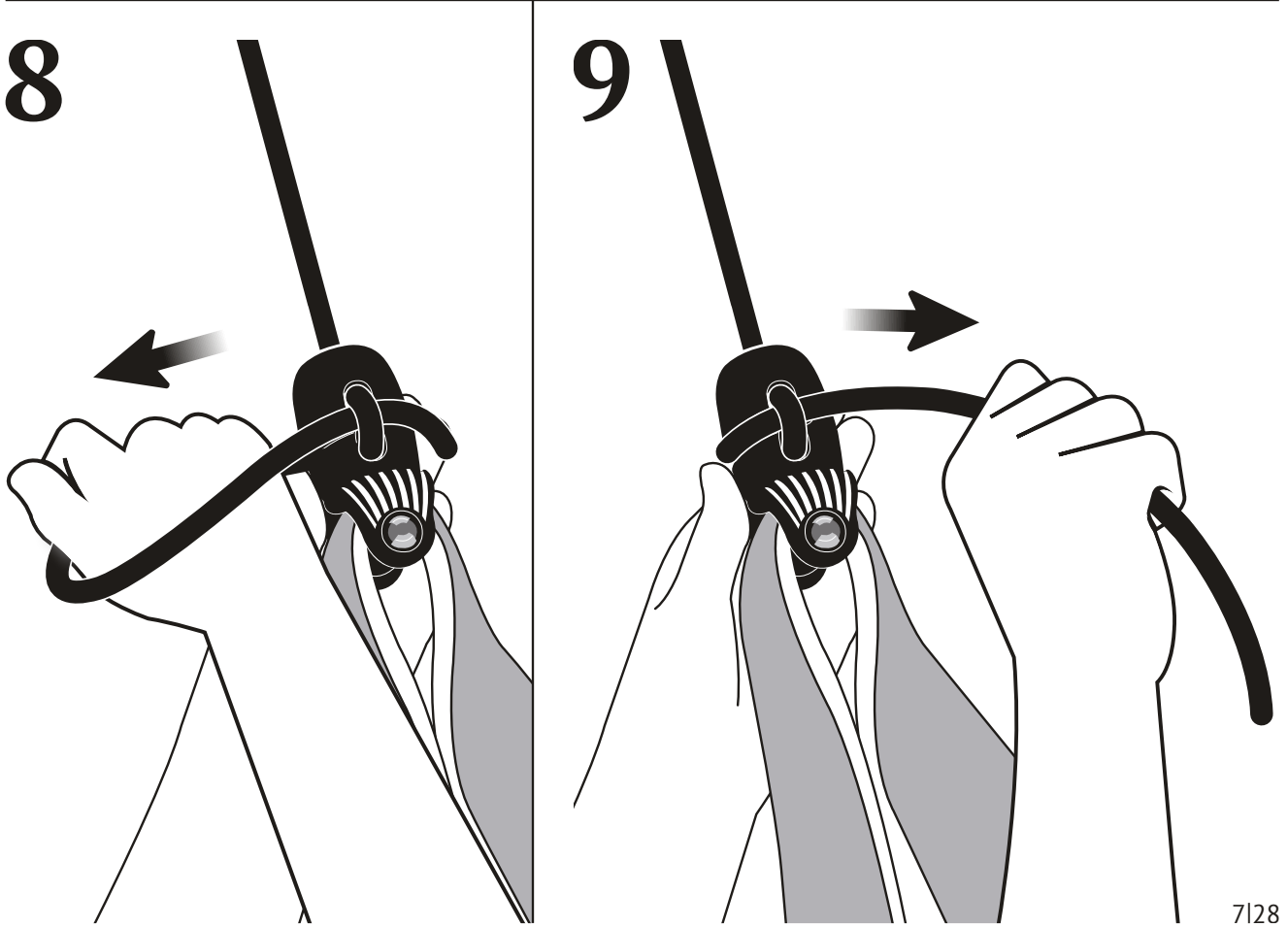
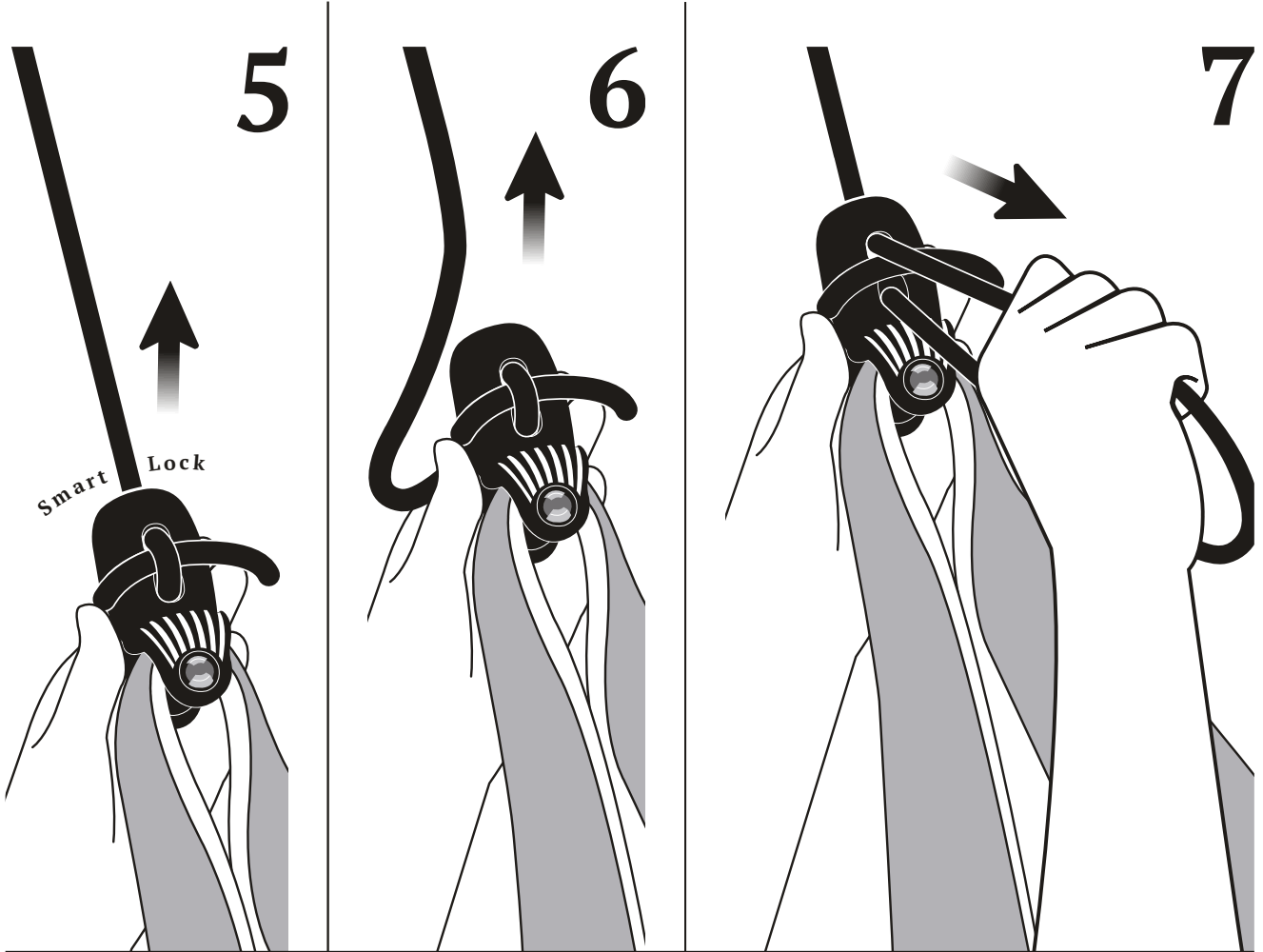

For Security and Care instructions,  
see the instruction manual of MOK16:  
[https://media.lasiesta.com/mediafiles/InstructionSheets/MOK\\_Manual\\_22-08-B.pdf](https://media.lasiesta.com/mediafiles/InstructionSheets/MOK_Manual_22-08-B.pdf)

